

STANDARD DIMENSION

Cover				
Product Code	Length (A) mm	Width (B) mm	Thickness mm	Weight kg
DC6684	600	600	80	52

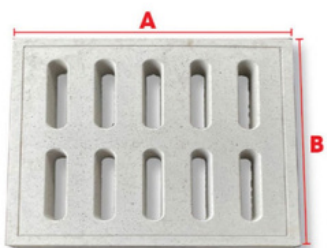

STANDARD DIMENSION

Cover				
Product Code	Length (A) mm	Width (B) mm	Thickness mm	Weight kg
DC66510	600	600	50	31

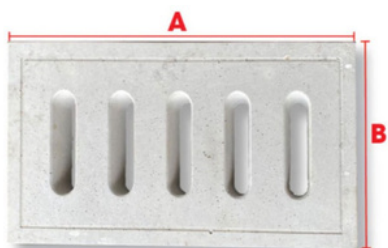

STANDARD DIMENSION

Cover				
Product Code	Length (A) mm	Width (B) mm	Thickness mm	Weight kg
DC6355	600	300	50	16

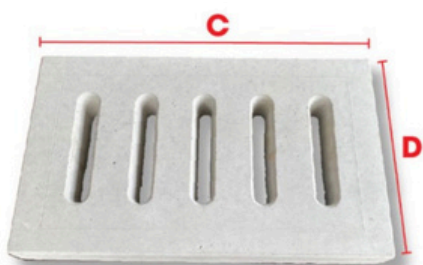

Cover

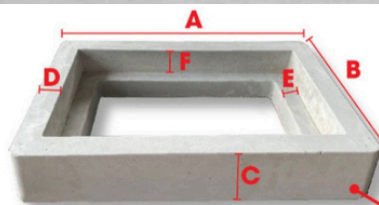

Frame



Thickness

STANDARD DIMENSION

Cover				
Product Code	Length (C) mm	Width (D) mm	Thickness mm	Weight kg
DC5365	500	300	60	18

Frame							
Product Code	A mm	B mm	C mm	D mm	E mm	F mm	Weight kg
CF5365	600	400	100	45	40	60	29

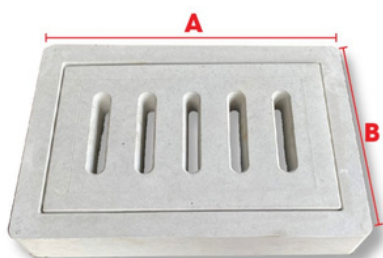

Combined

STANDARD DIMENSION

Combined				
Product Code	Length (A) mm	Width (B) mm	Thickness mm	Weight kg
DCF5365	600	400	100	47



\*The above measurements are based on standard measuring methods. Actual sizes may vary slightly.  
\*Our company reserves the right to modify the above sizes without prior notice.

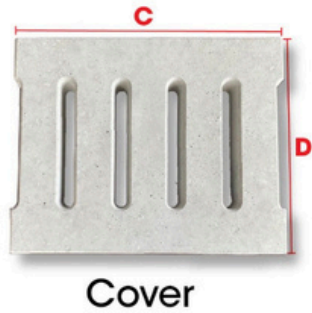

Cover

STANDARD DIMENSION

Cover				
Product Code	Length (C) mm	Width (D) mm	Thickness mm	Weight kg
DC5464	500	400	60	23

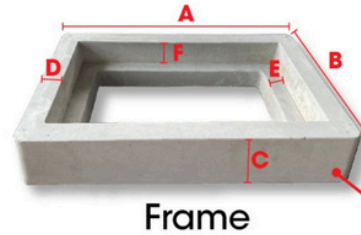

Frame



Frame							
Product Code	A mm	B mm	C mm	D mm	E mm	F mm	Weight kg
CF5464	600	500	100	45	35	50	35

STANDARD DIMENSION

Combined				
Product Code	Length (A) mm	Width (B) mm	Thickness mm	Weight kg
DCF5464	600	500	100	58

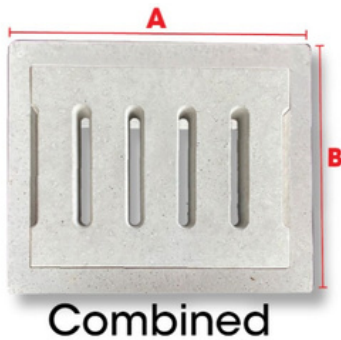

Combined

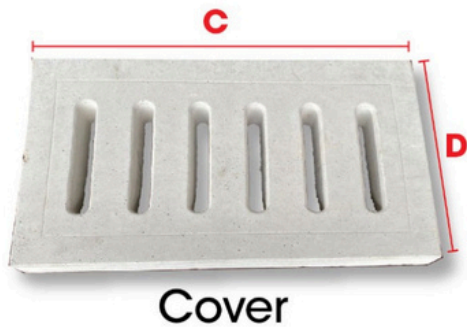

Cover

STANDARD DIMENSION

Cover				
Product Code	Length (C) mm	Width (D) mm	Thickness mm	Weight kg
DC6466	600	400	60	27

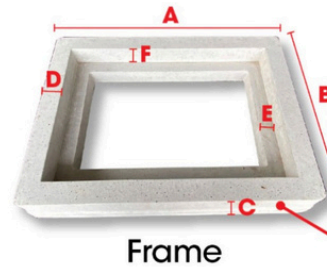

Frame



Frame							
Product Code	A mm	B mm	C mm	D mm	E mm	F mm	Weight kg
CF6466	700	500	100	50	40	60	41

STANDARD DIMENSION

Combined				
Product Code	Length (A) mm	Width (B) mm	Thickness mm	Weight kg
DCF6466	700	500	100	68

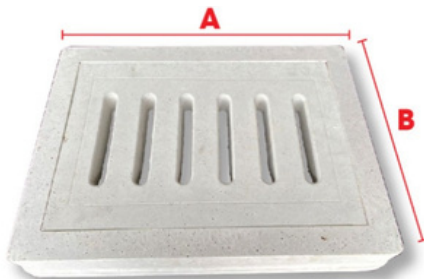

Combined



\*The above measurements are based on standard measuring methods. Actual sizes may vary slightly.  
\*Our company reserves the right to modify the above sizes without prior notice.



# REINFORCED CONCRETE DRAIN COVER & FRAME

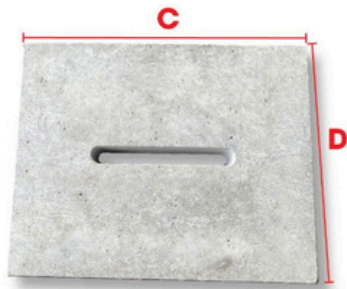

Cover

STANDARD DIMENSION

Cover				
Product Code	Length (C) mm	Width (D) mm	Thickness mm	Weight kg
DC5461	500	400	60	26

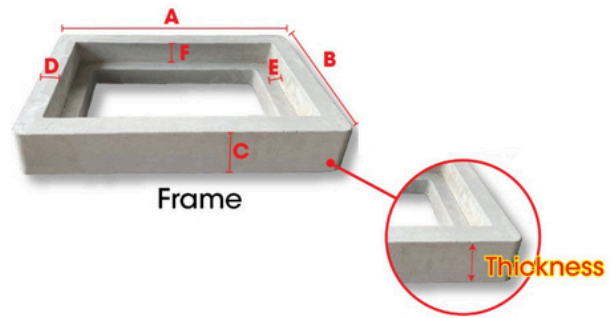

Frame

Frame							
Product Code	A mm	B mm	C mm	D mm	E mm	F mm	Weight kg
CF5461	600	500	100	45	35	50	35

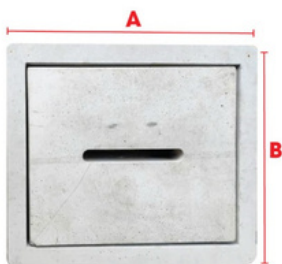

Combined

STANDARD DIMENSION

Combined				
Product Code	Length (A) mm	Width (B) mm	Thickness mm	Weight kg
DCF5461	600	500	100	61

# REINFORCED CONCRETE MANHOLE COVER & FRAME

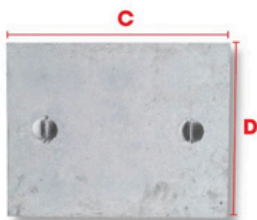

Cover

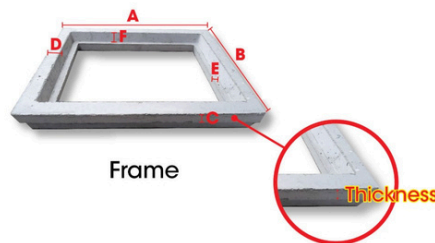

Frame

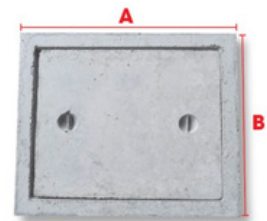

Combined

SET: 31.7kg

STANDARD DIMENSION

Cover				
Product Code	Length (C) mm	Width (D) mm	Thickness mm	Weight kg
M1824C	530	430	40	15.3

Frame							
Product Code	A mm	B mm	C mm	D mm	E mm	F mm	Weight kg
M1824C	630	530	80	50	20	40	16.4

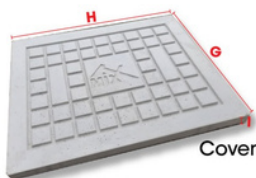

Cover

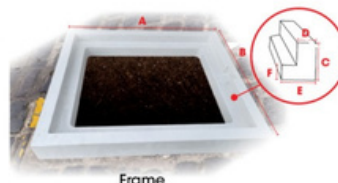

Frame



SET: 25kg

STANDARD DIMENSION

Cover				
Product Code	G mm	H mm	I mm	Weight kg
MC1824A	400	500	30	11

Frame							
Product Code	A mm	B mm	C mm	D mm	E mm	F mm	Weight kg
MC1824A	570	470	70	30	70	40	14



\*The above measurements are based on standard measuring methods. Actual sizes may vary slightly.  
\*Our company reserves the right to modify the above sizes without prior notice.



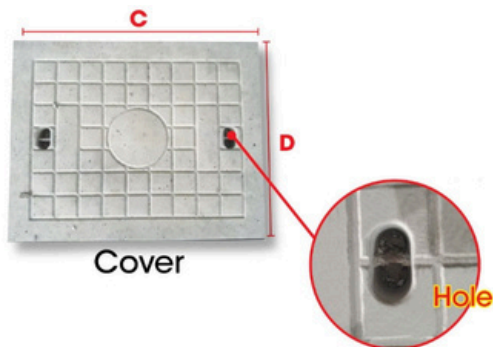

Cover

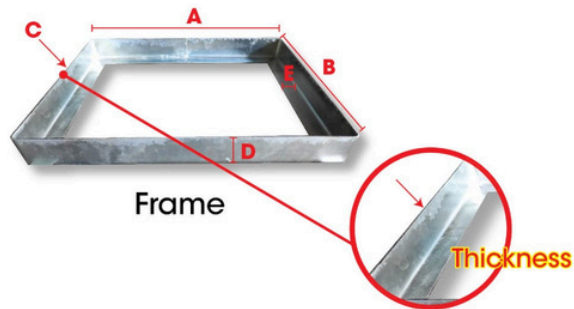

Frame

STANDARD DIMENSION

Cover				
Product Code	Length (C) mm	Width (D) mm	Thickness mm	Weight kg
MC5560	500	500	60	32

Frame						
Product Code	A mm	B mm	C mm	D mm	E mm	Weight kg
SF5560	510	510	2.5	60	30	3.6

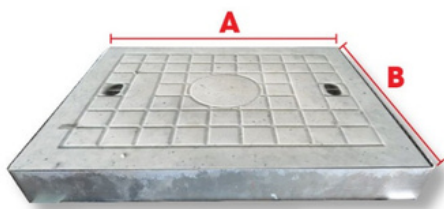

Combined

STANDARD DIMENSION

Combined				
Product Code	Length (A) mm	Width (B) mm	Thickness mm	Weight kg
MCSF5560	510	510	60	35.6

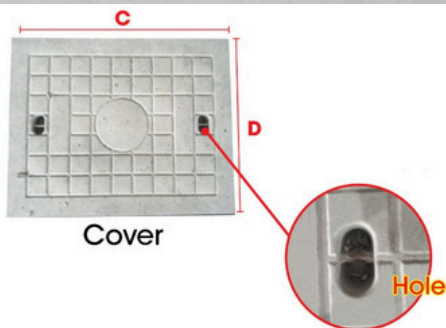

Cover

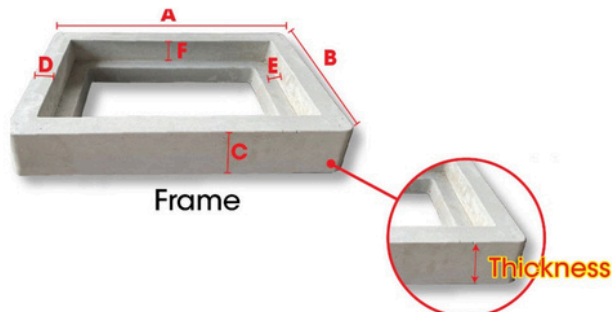

Frame

STANDARD DIMENSION

Cover				
Product Code	Length (C) mm	Width (D) mm	Thickness mm	Weight kg
MC5560	500	500	60	32

Frame							
Product Code	A mm	B mm	C mm	D mm	E mm	F mm	Weight kg
CF5560	600	600	100	50	40	60	38

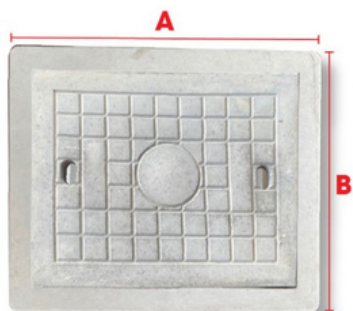

Combined

STANDARD DIMENSION

Combined				
Product Code	Length (A) mm	Width (B) mm	Thickness mm	Weight kg
MCF5560	600	600	100	70



\*The above measurements are based on standard measuring methods. Actual sizes may vary slightly.  
\*Our company reserves the right to modify the above sizes without prior notice.

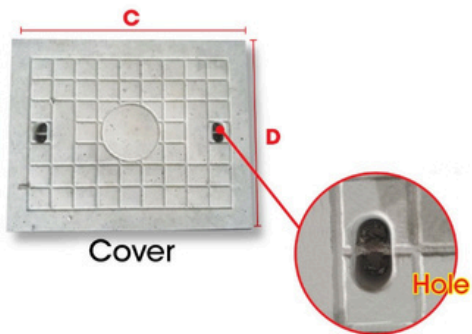

Cover

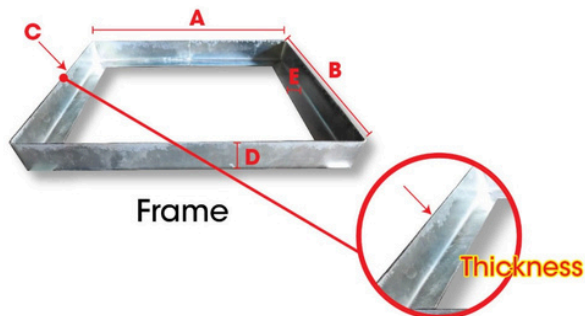

Frame

STANDARD DIMENSION

Cover				
Product Code	Length (C) mm	Width (D) mm	Thickness mm	Weight kg
MC5460	500	400	60	27

Frame						
Product Code	A mm	B mm	C mm	D mm	E mm	Weight kg
SF5460	510	410	2.5	60	30	3.4

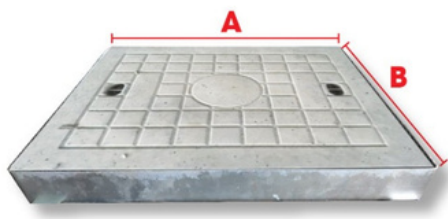

Combined

STANDARD DIMENSION

Combined				
Product Code	Length (A) mm	Width (B) mm	Thickness mm	Weight kg
MCSF5460	510	410	60	30.4

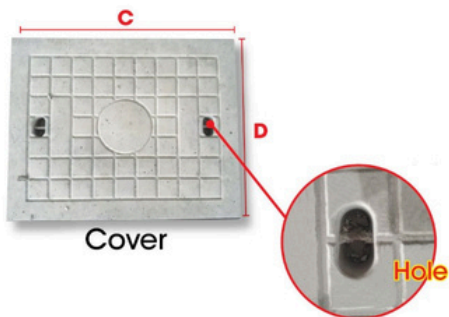

Cover

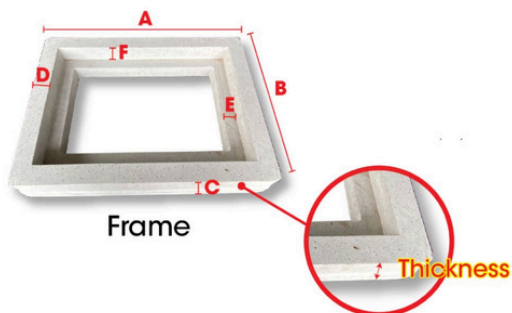

Frame

STANDARD DIMENSION

Cover				
Product Code	Length (C) mm	Width (D) mm	Thickness mm	Weight kg
MC5460	500	400	60	27

Frame							
Product Code	A mm	B mm	C mm	D mm	E mm	F mm	Weight kg
CF5460	600	500	100	45	35	50	35

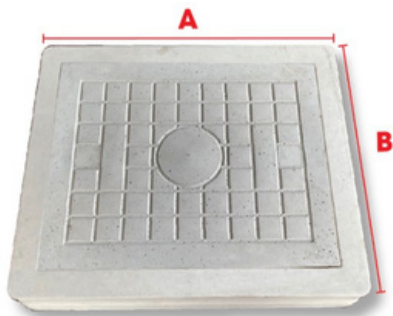

Combined

STANDARD DIMENSION

Combined				
Product Code	Length (A) mm	Width (B) mm	Thickness mm	Weight kg
MCF5560	600	600	100	70



\*The above measurements are based on standard measuring methods. Actual sizes may vary slightly.  
\*Our company reserves the right to modify the above sizes without prior notice.